

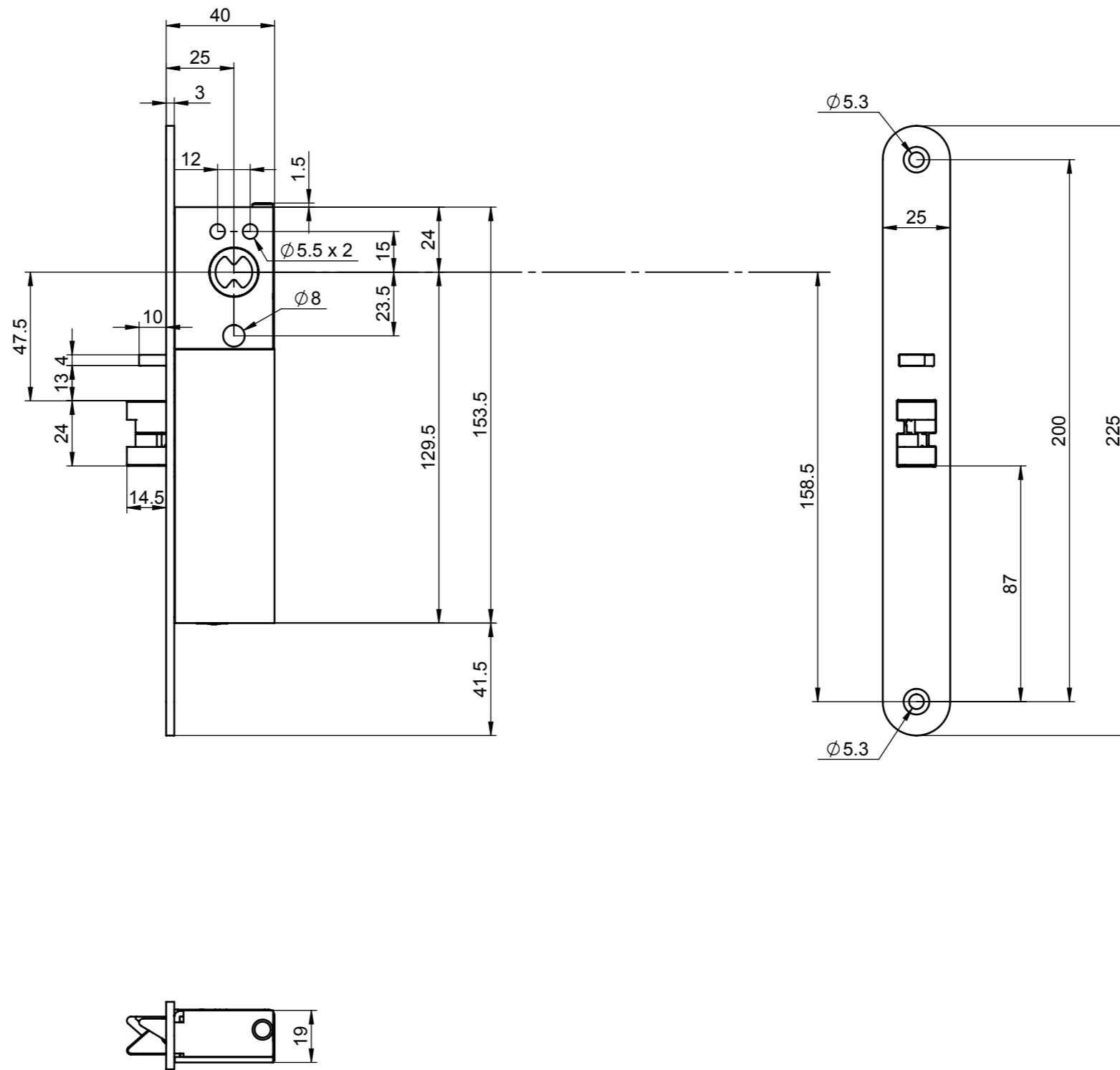

This document is our property and shall not without our permission be altered, copied, used for manufacturing or communicated to any other person or company.



Surface: 456466		Material:			General tolerance: ISO 2768-mH	
Volume:	Weight:	Surface area:	created: 21.01.2015 JK	designed by:	changed by:	Scale: 1:2 (A3)
 Abloy Oy An ASSA ABLOY Group brand		ABLOY EL402 / 25			Projection: 	
		Document ID		Rev.: 1		

Part/assy:

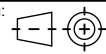
Configuration:Default

SHEET 1 OF 1