

This document is our property and shall not without our permission be altered, copied, used for manufacturing or communicated to any other person or company.

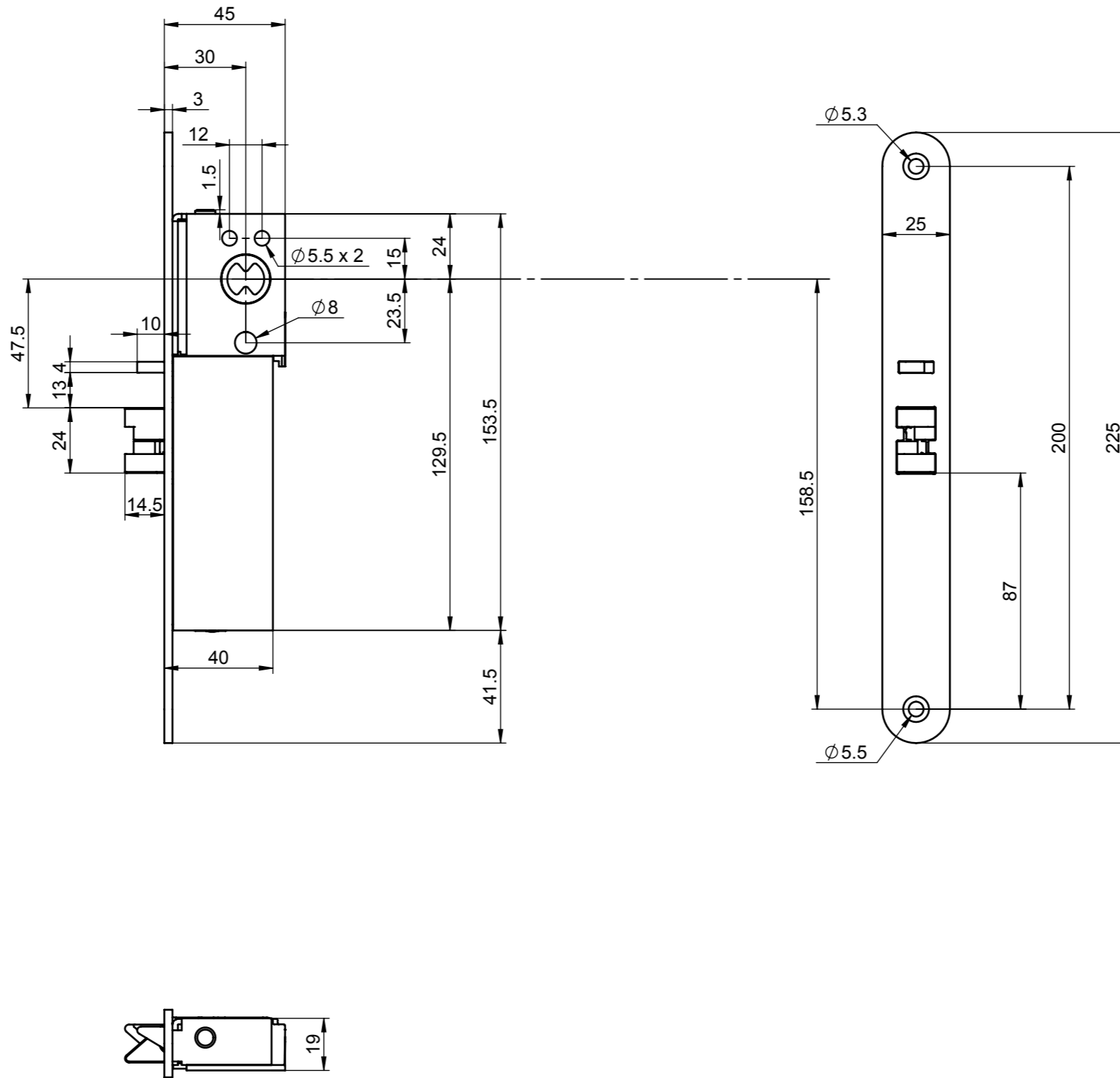

Surface: 456466			Material:			General tolerance: ISO 2768-mH	
Volume:	Weight:	Surface area:	created: 21.01.2015 JK	designed by:	changed by:	Scale: 1:2 (A3)	Projection:
 Abloy Oy An ASSA ABLOY Group brand			ABLOY EL402 / 30			Alternate ID	
						Document ID	Rev.: 1

Part/assy:

Configuration:Default

SHEET 1 OF 1